

NWF2205

MANUAL OPERATION TABLE

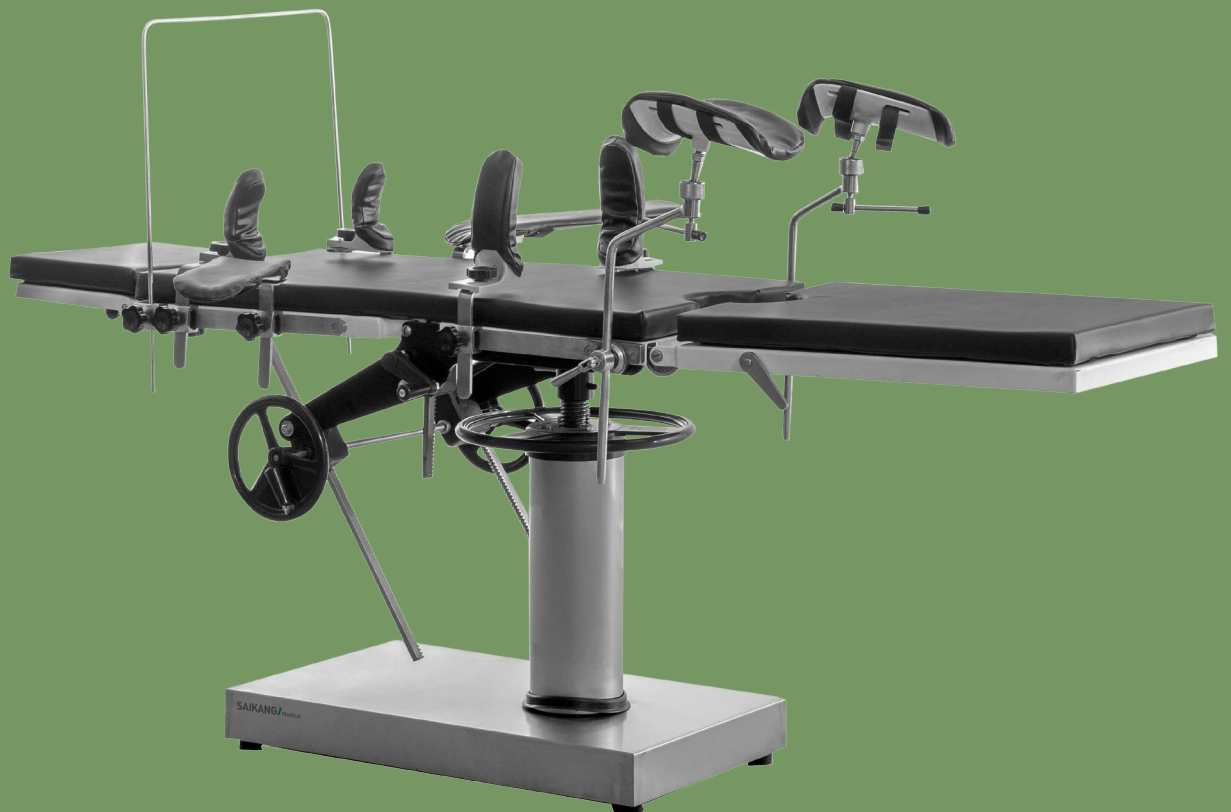

NWF2205

FEATURES AND HIGHLIGHTS

Technical parameters

▪ External size (LxWxH):	2000x480x(700-960)mm
▪ Head plate up/down:	45°/90°
▪ Back plate up:	0-80°
▪ Leg plate down:	0-90°
▪ Safe working load:	150kg

Technical configuration

<input checked="" type="checkbox"/> Arm support	2 pcs
<input checked="" type="checkbox"/> Leg support	2 pcs
<input checked="" type="checkbox"/> Body Support	2 pcs
<input checked="" type="checkbox"/> Shoulder Support	2 pcs
<input checked="" type="checkbox"/> Anaesthetic Screen	1 pc

Professional functions

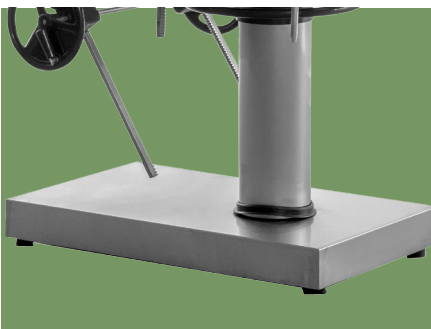
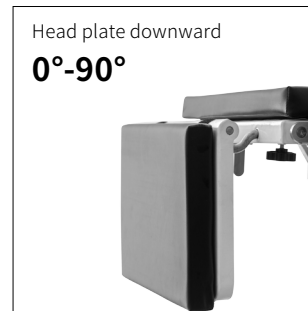
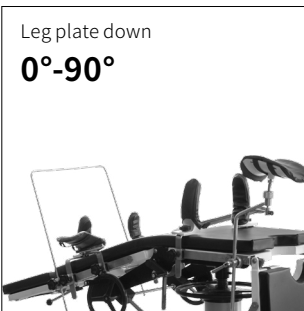
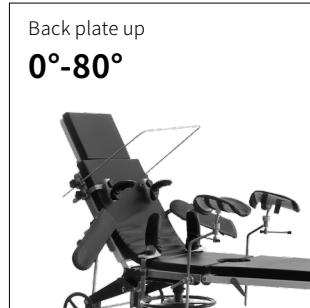

Material

Base structure is made of high-quality 304 stainless steel, robot welded with high strength and modern appearance.
Table top is made of steel through epoxy painting, ASTM testing anti-bacterial.

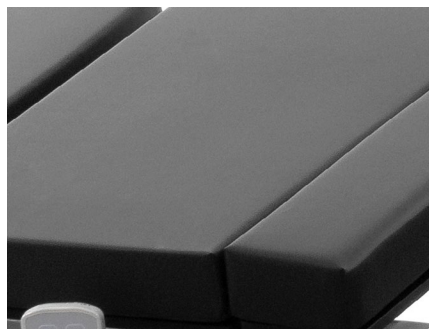

Mattress

Removable memory mattress.
Good resilience, anti-static, antibacterial, impact resistant.



Control System

All the functions are manual controlled by screw and rack.

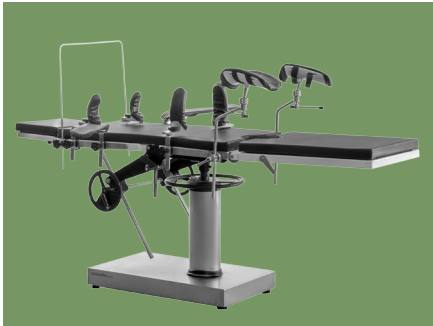

Structure

Full mechanical structure.
Simple maintenance, low failure rate.

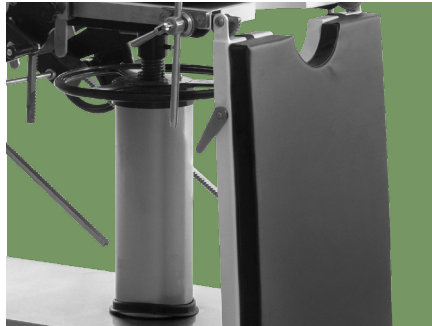

Leg board

Leg board can be folded down by adjusting the small handle.
Leg board down: max. to 90°.



Armrest

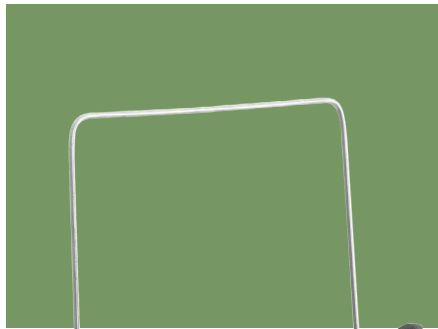

Anesthesia Frame



Leg Crutches



Shoulder Support



Body Supporter

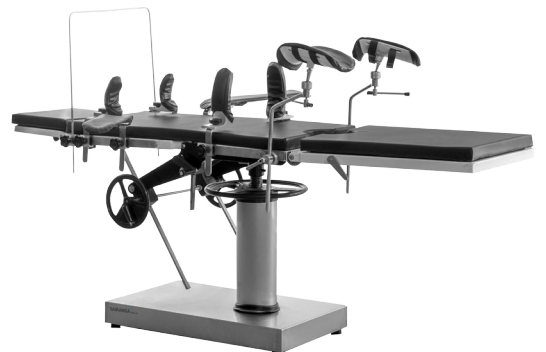



NUMBER WIN

MEDICAL TECHNOLOGY



7x24

Online 24 Hours for Sales Service
Timely Response for Clients' Problems

+86 18021231901

Suzhou Number Win Medical Technology Co.,Ltd.

No. 35, Lehong Road · Zhangjiagang (Jiangsu) · China

export@number-win.com

www.number-win.com

As the circumstance of printing, the photos might have minor difference on color, tactile from real products.
As the update of design and improvement, parameters and outlook of products might change, thanks for understanding.



Company video



General catalogue